

alea

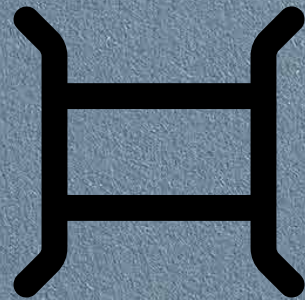

Rendez-Vous

workstations

Lo spazio ibrido diventa realtà

Rendez-Vous nasce
come collezione
adattabile alle
diverse funzioni
dell'ambiente
di lavoro
contemporaneo.

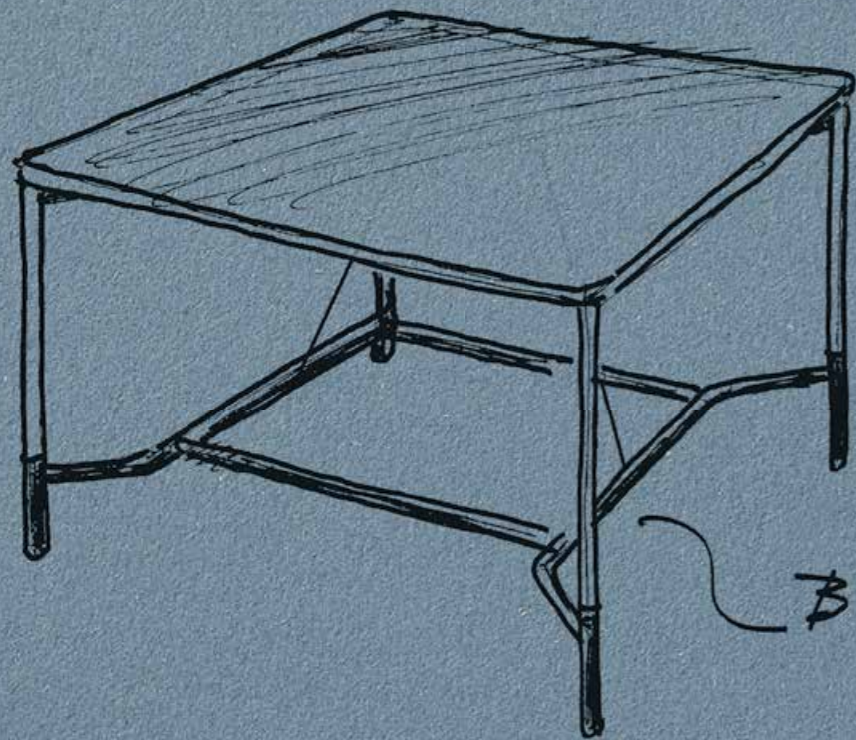

BICOLOR

Rendez-Vous was created
as a collection adaptable to
the multiple functions of the
contemporary workplace.

Rendez-Vous a été créé
comme une collection
adaptable aux différentes
fonctions de l'environnement
de travail contemporain.

Rendez-Vous nasce como
una colección adaptable
a las diferentes funciones
del entorno de trabajo
contemporáneo.

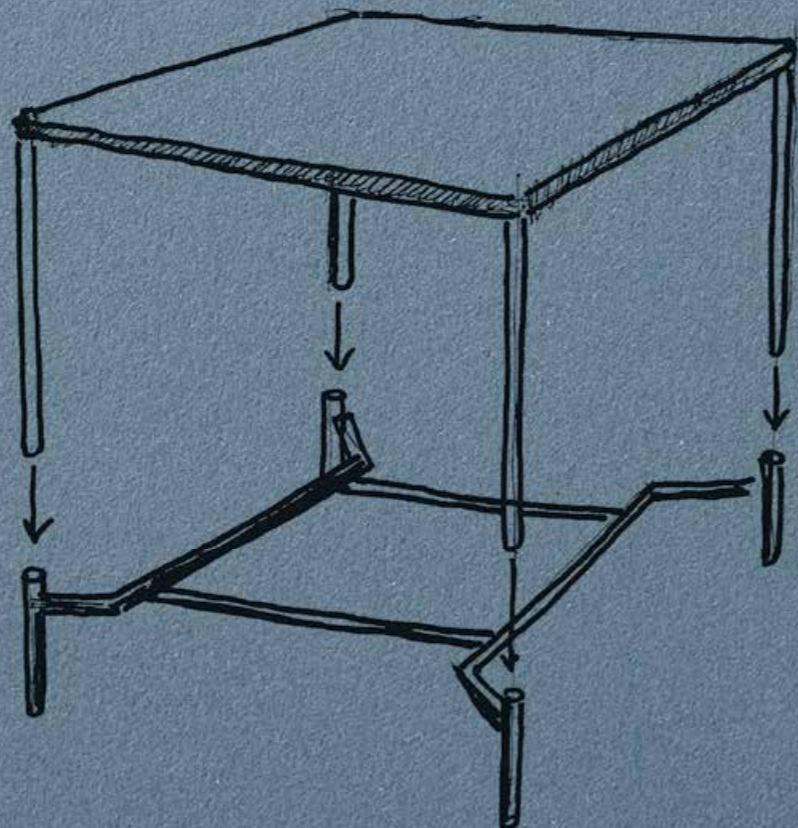



Condivisione

Rendez-Vous è stato progettato per agevolare la condivisione dello spazio. In un'epoca dove la flessibilità in termini di modi e luoghi diventa un must, questa collezione si apre a molteplici interpretazioni.



Tavolo | Table | Table | Mesa **Fin.** MD, EI, EE
 L/P 160 H 105 cm | W/D 63" H 41 3/8"

Sharing Rendez-Vous is designed to create collaboration spaces. In an age where flexibility in terms of ways and places is becoming a must, this collection is open to multiple interpretations.

Compartir Rendez-Vous ha sido diseñado para facilitar el uso compartido del espacio. En una época en la que la flexibilidad en términos de modos y lugares se hace imprescindible, esta colección se abre a múltiples interpretaciones.

Partager Rendez-Vous est conçu pour créer des espaces de collaboration. À une époque où la flexibilité en termes de moyens et de lieux devient un must, cette collection est ouverte à de multiples interprétations.

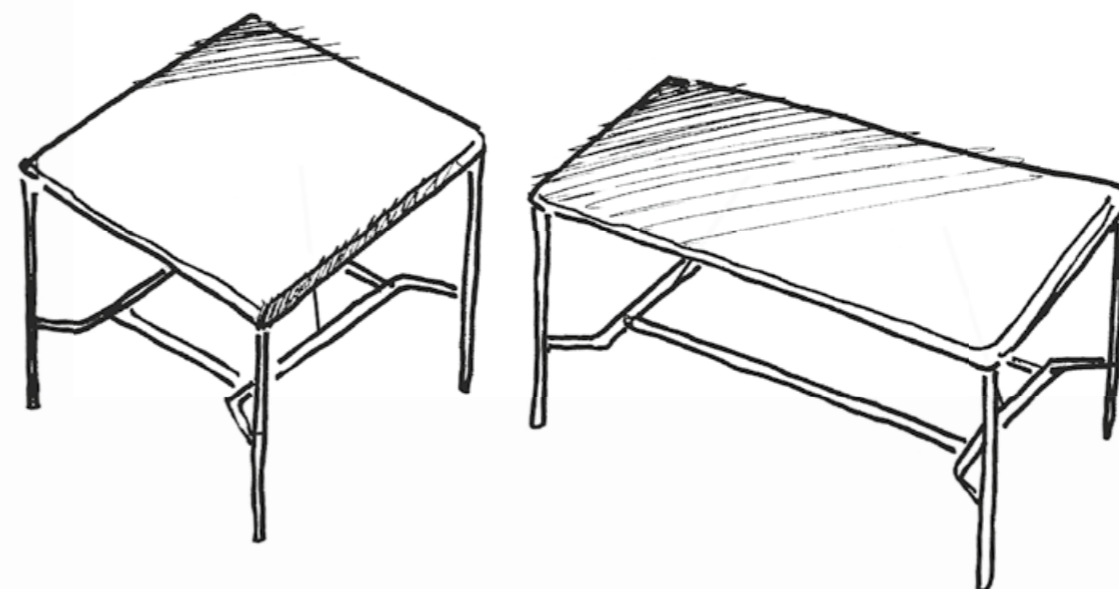



Bench | Bench | Bench | Bench **Fin.** MD, EI
L 300 P 100 H 73,4 cm | W 118 1/8" D 39 3/8" H 28 7/8"



Leggerezza

La struttura è composta da gambe tubolari in metallo verniciato dal diametro di 35 mm, che supportano piani di spessore 18 mm. Gli angoli possono essere sia dritti che raggiati. Nel secondo caso la curva creata va ad armonizzare il punto dove piano e gamba si incontrano.



Bench | Bench | Bench | Bench | Bench **Fin.** Mi, EO, DC
L 400 **P** 160 **H** 73,4 cm | **W** 157 1/2" **D** 63" **H** 28 7/8"

Lightweight The structure is composed of tubular legs in painted metal with a diameter of 35 mm (1 3/8"), which support 18 mm (11/16") thick tops. The corners can be either straight or round. In the second case, the curve creates the point where top and leg meet.

Légèreté La structure est composée de pieds tubulaires de 35 mm de diamètre en métal peint, qui soutiennent des plateaux de 18 mm d'épaisseur caractérisés par un rayon sur les quatres angles, qui harmonise le point de jonction des deux éléments.



Tavolo | Table | Table | Mesa **Fin.** Mi, EO, EI
L 300 **P** 100 **H** 105 cm | **W** 118 1/8" **D** 39 3/8" **H** 41 3/8"

Ligereza La estructura se compone de patas tubulares de 35 mm de diámetro en metal pintado, que soportan tableros de 18 mm de grosor. Las esquinas pueden ser rectas o redondeadas. En este último caso la curva que se crea armoniza el punto de encuentro entre sobre y pata.



I piani sono ampi e la palette di finiture disponibili comprende tutti i colori dei melaminici, degli impiallacciati e dei Fenix standard Alea.



Tops are wide and the palette of available finishes includes all colours of Alea standard melamine, veneer and Fenix.

Les plateaux sont larges et la palette des finitions disponibles comprend toutes les couleurs de la mélamine, du placage et du Fenix standard Alea.

Las encimeras son amplias y la paleta de acabados disponibles incluye todos los colores de melamina, chapa de madera y Fenix estándar de Alea.

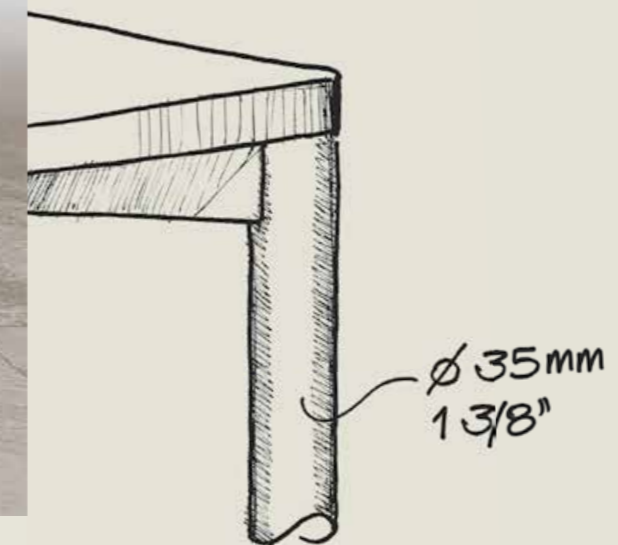

Eleganza informale

Rendez-Vous si adatta molto bene ad arredare uffici privati e manageriali. L'impiallacciatura del top impreziosisce tutto il suo design, del quale persiste l'eleganza informale.



Élégance informelle Rendez-Vous est bien adapté aux bureaux privés et aux bureaux de direction. Le plateau en bois plaqué embellit l'ensemble de son design, dont l'élégance informelle persiste.

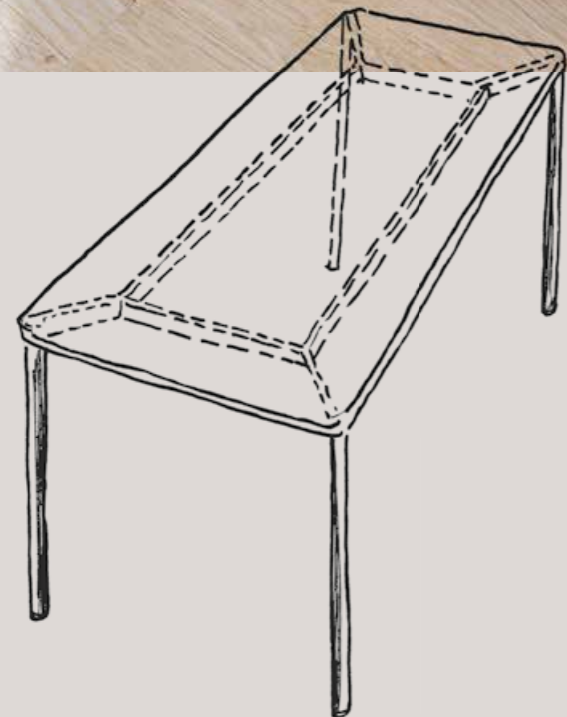

Informal elegance Rendez-Vous is well suited to private and managerial offices. The veneered top enhances the whole design, whose informal elegance persists.



Elegancia informal Rendez-Vous se adapta bien a las oficinas privadas y de dirección. La encimera chapada embellece todo su diseño, cuya elegancia informal persiste.

Scrivania | Desk | Bureau | Mesa **Fin.** ML, EN
L 220 **P** 100 **H** 73,4 cm | **W** 94 1/2" **D** 47 1/4" **H** 28 7/8"





Scrivania | Desk | Bureau | Mesa **Fin.** MK, EZ
L 200 P 80 H 73,4 cm | W 78 3/4" D 31 1/2" H 28 7/8"
Tavolo | Table | Mesa **Fin.** MK, EZ
L 200 P 120 H 105 cm | W 78 3/4" D 47 1/4" H 41 3/8"

Les tables Rendez-Vous peuvent couvrir une longueur de 300 cm maxi aux meubles de service équipés de tiroirs et compartiments ouverts avec top arrondis.

Las mesas Rendez-Vous pueden cubrir luces de hasta 300 cm y se adaptan bien a los contenedores de servicio con tableros redondeados que vienen con cajones y compartimentos abiertos.



I tavoli Rendez-Vous arrivano a coprire campate di 300 cm e ben si abbinano ai contenitori di servizio con top dagli angoli arrotondati che si propongono con cassettera e vano a giorno.

Rendez-Vous tables can cover spans of up to 300 cm (118 1/8") and are well matched to the service units with rounded-corner tops, which are offered with drawers and open compartment.

Home office

La semplicità di Rendez-Vous lo rende un elemento facile da inserire all'interno di un contesto domestico. I volumi e il comfort dell'ufficio si trasferiscono a casa.





Rendez-Vous simplicity makes it an easy element to integrate into a domestic context. Office volumes and comfort are transferred at home.

Scrivania | Desk | Bureau | Mesa **Fin.** NT, EZ
 L 200 P 100 H 73,4 cm | W 78 3/4" D 39 3/8" H 28 7/8"

La simplicité de Rendez-Vous en fait le rend un élément facile à intégrer dans un contexte domestique. Les volumes et le confort du bureau sont transférés à la maison.

La sencillez de Rendez-Vous hace que sea un elemento fácil de integrar en un contexto doméstico. Los volúmenes y el confort de la oficina se trasladan al hogar.





Tavolo | Table | Mesa **Fin.** MD, El, YB
 L 160 P 80 H 73,4 cm | W 63" D 31 1/2" H 28 7/8"
Tavolo | Table | Mesa **Fin.** MD, El, YB
 L 220 P 80 H 105 cm | W 86 5/8" D 31 1/2" H 41 3/8"





Tavolo | Table | Table | Mesa **Fin.** MT, ET, EO
Ø 150 H 90 cm | Ø 59" H 35 3/8"
Tavolo | Table | Table | Mesa **Fin.** MT, ET, EO
Ø 120 H 105 cm | Ø 47 1/4" H 41 3/8"



Height Tables start at a height of 73,4 cm (28 7/8"), which can be increased to 90 (35 3/8") or 105 cm (41 3/8") thanks to an additional base frame with footrest, which can be painted in a different colour and can be added or removed as required.

Altezze

I tavoli partono da un'altezza di 73,4 cm, che si può aumentare arrivando a 90 o 105 cm. Questo incremento avviene grazie ad una struttura di base addizionale, provvista di poggiapiedi, che si può colorare diversamente rispetto alle gambe e può essere aggiunta o rimossa a piacere.

Hauteur La première hauteur de la table est de 73,4cm, qu'on peut augmenter jusqu'à 90cm ou 105 cm. Ces dernières dimensions peuvent être atteints grâce à une structure additionnelle équipée de repose-pieds, qui peut avoir une finition différente par rapport au pieds fixes. Elle pourra être ajoutée et enlevée à discrétion.

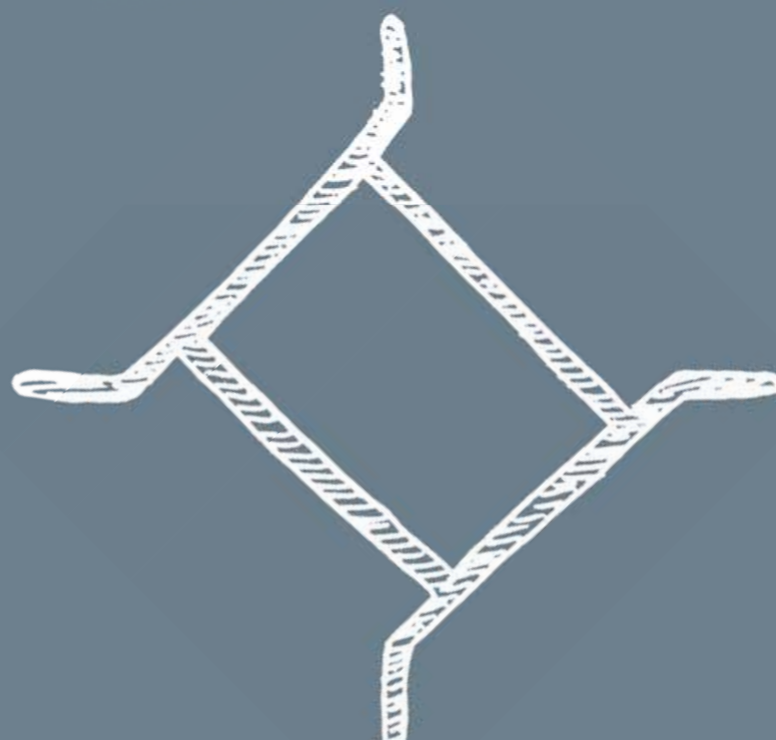
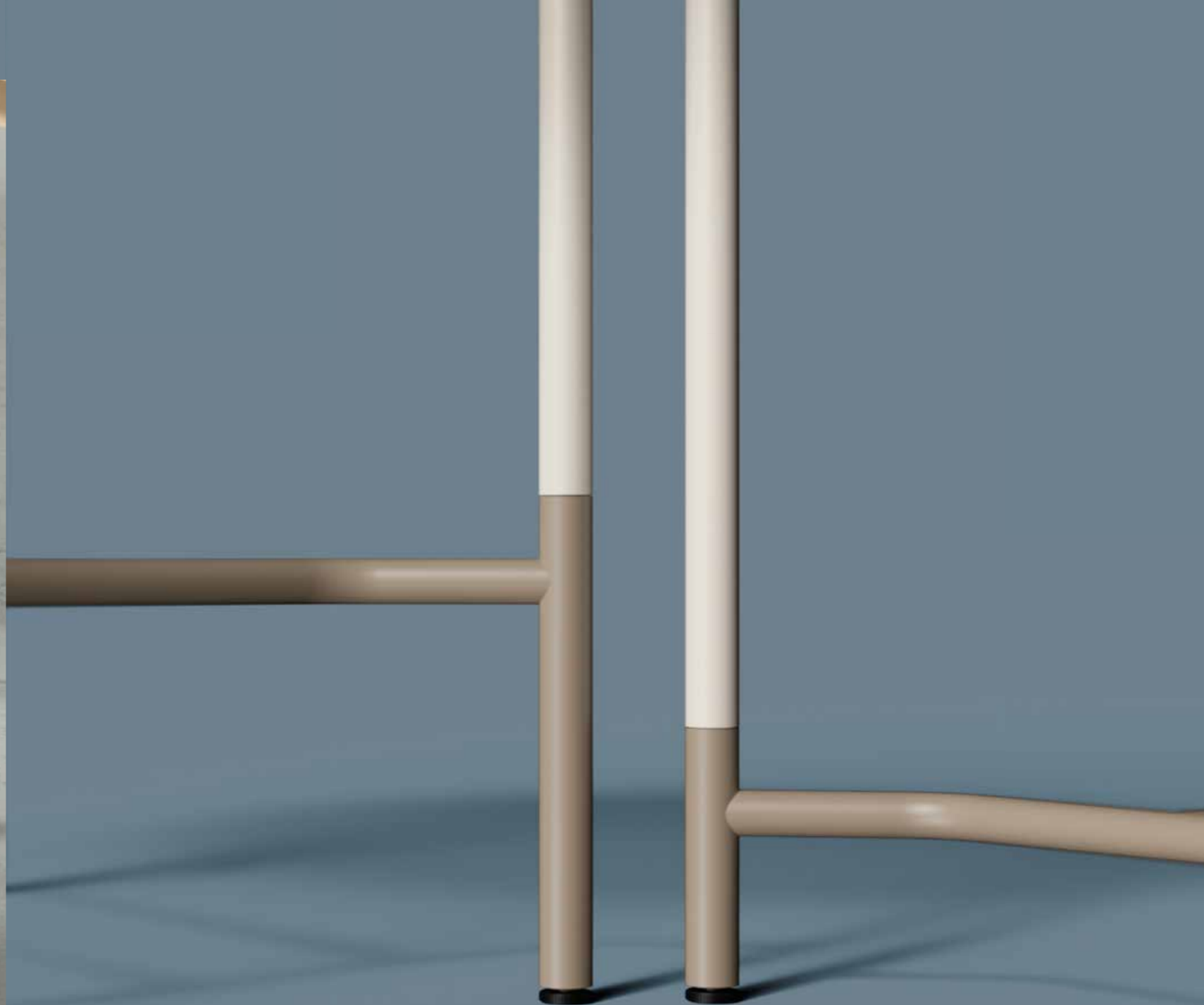

Altura Las mesas parten de una altura de 73,4 cm, que se puede aumentar alcanzando los 90 o 105 cm. Este aumento se produce gracias a una estructura básica adicional, equipada con reposapiés, que se puede colorar de un color diferente de las patas y se puede añadir o eliminar a voluntad.

Opzioni

Per i tavoli H 73,4 e H 105 cm fino a lunghezza 200 cm, è disponibile la versione su ruote. Queste vengono innestate in una struttura apposita così da mantenere invariata l'altezza del piano.

Options For tables H 73,4 (28 7/8") and H 105 cm (41 3/8") up to a length of 200 cm (78 3/4"), a version with castors is available. These are inserted into a special structure so that the height of the table top does not change.

Options Pour les tables H 73,4 et H 105 cm jusqu'à une longueur de 200 cm, une version avec roulettes est disponible. Celles-ci sont insérées dans une structure spéciale de sorte que la hauteur du plateau de la table ne change pas.

Opciones Para mesas H 73,4 y H 105 cm hasta una longitud de 200 cm, hay disponible una versión con ruedas. Éstas se insertan en una estructura especial para que la altura del tablero de la mesa no varíe.

Tavolo | Table | Mesa **Fin.** MW, EZ, EN
L/P 150 H 105 cm | W/D 59" H 41 3/8"





Forme

I piani dei tavoli Rendez-Vous possono avere forme particolari come quella a 8 (che permette l'accostamento di due diversi colori) oppure quella ovoidale.

Shapes The tops of Rendez-Vous tables can have special shapes such as the 8-shape (which allows the combination of two different colours) or the ovoid shape.

Formes Les plateaux des tables Rendez-Vous peuvent avoir des formes particulières comme la forme en 8 (qui permet de combiner deux couleurs différentes) ou la forme ovoïde.

Formas Los tableros de las mesas Rendez-Vous pueden tener formas especiales, como la forma de 8 (que permite combinar dos colores distintos) o la forma ovalada.



Tavolo | Table | Mesa **Fin.** | MT, MJ, ET, EI
 L 240 P 140 H 105 cm | W 94 1/2" D 55 1/8" H 41 3/8"



Tavolo | Table | Mesa | Mesa **Fin.** ML, EN
L 240 P 140 H 73,4 cm | W 94 1/2" D 65 1/8" H 28 7/8"

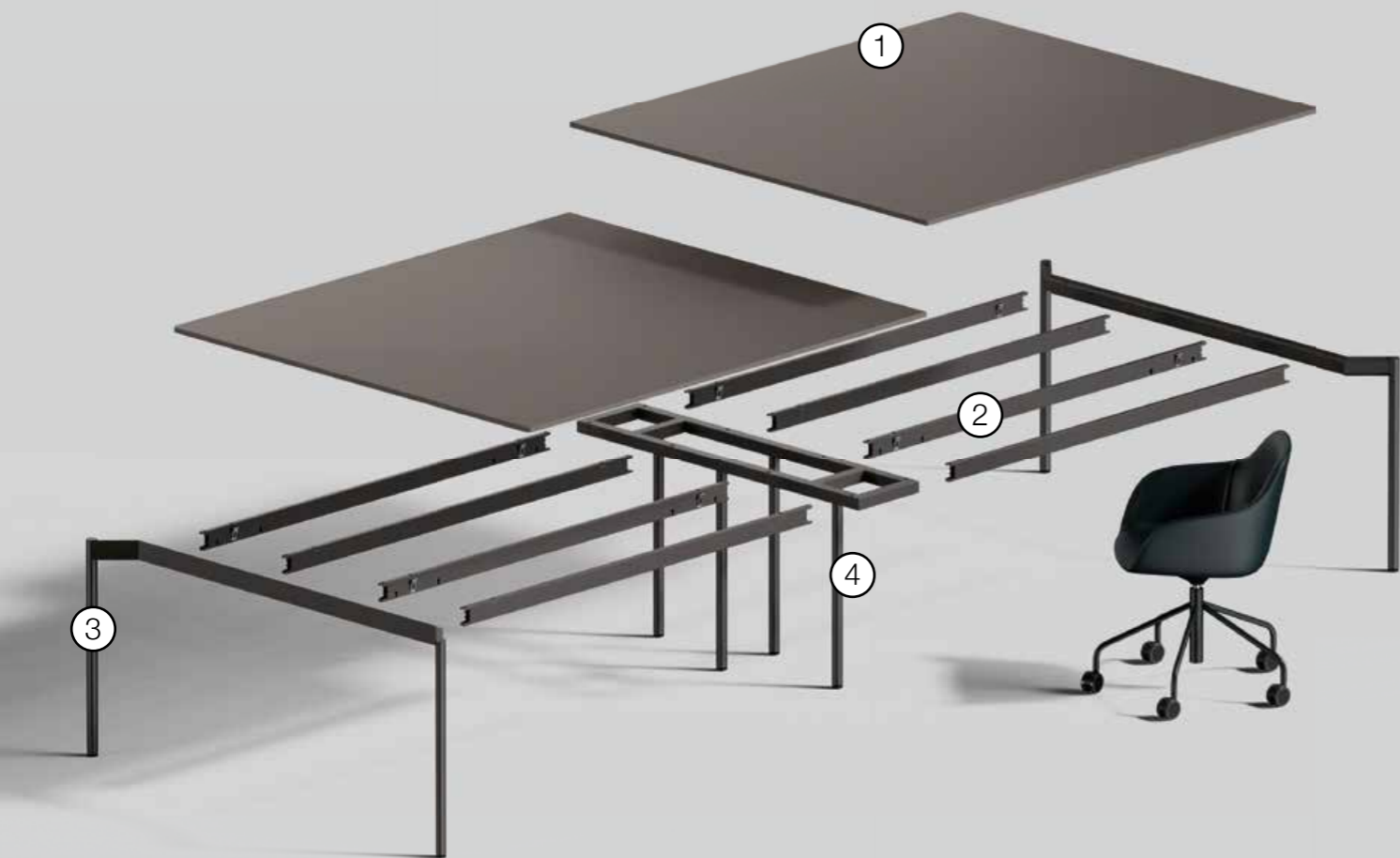

1. Piani per bench fino a 200x160 cm | 2. Longheroni | 3. Gambe terminali | 4. Gamba intermedia per tavoli multipli/bench

1. Bench tops up to 200x160 cm (78 3/4"x 63") | 2. Structural beams | 3. End legs | 4. Intermediate legs for multiple tables/benches

1. Plateaux pour tables jusqu'à 200x160 cm | 2. Poutres | 3. Pieds terminaux | 4. Pied intermédiaire pour tables multiples/bench

1. Sobres para bench hasta 200x160 cm | 2. Travesaños | 3. Patas terminales | 4. Pata intermedia para mesas múltiples/bench



Piani | Desk tops | Plateaux | Sobres
 Spessore **1,8 cm** | 1,8 cm (3/4") thick | 1,8 cm d'épaisseur | 1,8 cm de espesor

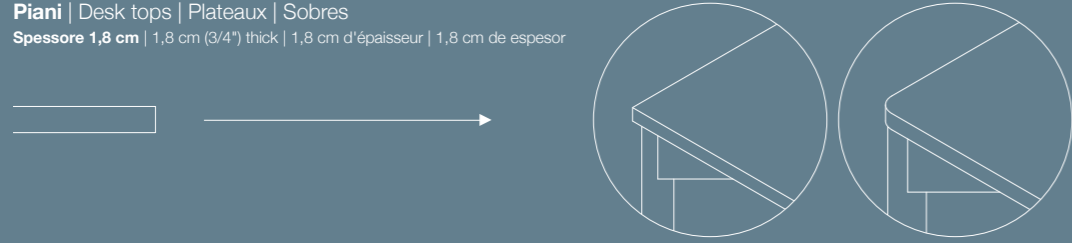

Struttura | Structure | Structure | Estructura
 Sezione **Ø 3,5 cm** | Section Ø 3.5 cm (1 3/8") | Section Ø 3,5 cm | Sección Ø 3,5 cm

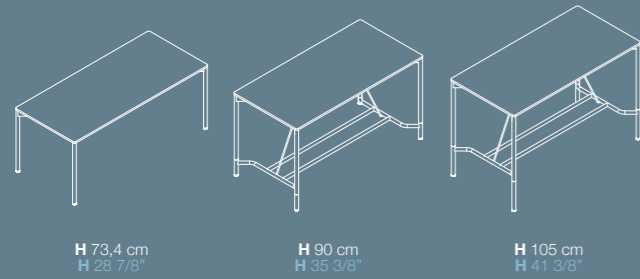

Ruote disponibili per H 73,4 e H 105 cm fino a L 200 cm
 Castors available for H 73.4 (28 7/8") and H 105 cm (41 3/8") up to W 200 cm (78 3/4")
 Roulettes disponibles pour H 73,4 et H 105 cm jusqu'à L 200 cm
 Ruedas disponibles para H 73,4 y H 105 cm hasta L 200 cm

Scrivanie/tavoli | Desks/tables | Bureaux/tables | Mesas

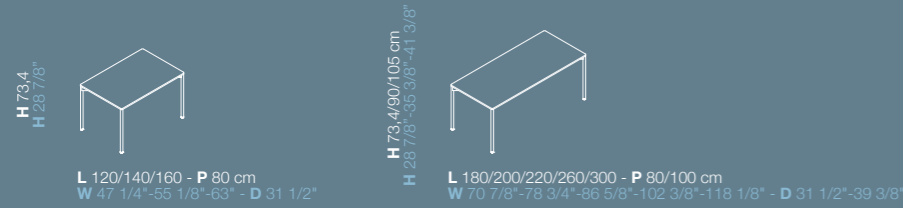

Bench | Bench | Bench | Bench

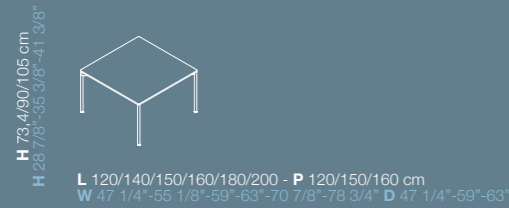

Bench/tavoli multipli | Bench/multiple tables | Bench/tables multiples | Bench/múltiples mesas

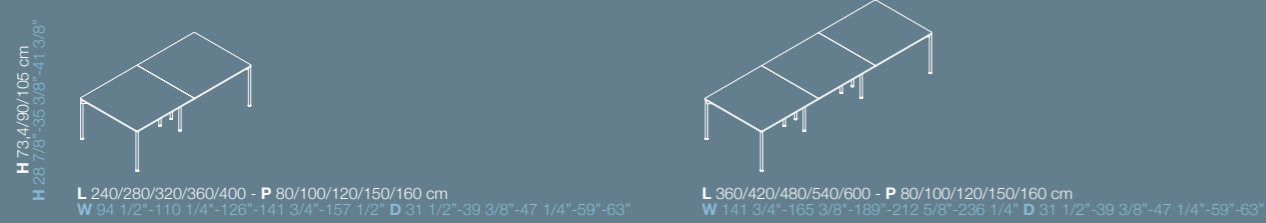

Tavoli riunione | Meeting tables | Tables de réunion | Mesas de juntas

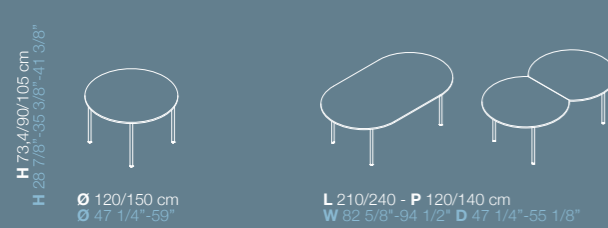

Finiture | Finishes | Finitions | Acabados

TOP

MEL

Melaminico

Melamine | Mélaminé | Melaminico



Bianco rigato
 Rippled effect white
 Blanc avec rayures en sérigraphie
 Blanco rayado

Grigio rigato
 Rippled effect grey
 Gris avec rayures en sérigraphie
 Gris rayado

Nichel
 Nickel
 Nickel
 Niquel

Cacao
 Cocoa
 Cacao
 Cacao

Bianco
 White
 Blanc
 Blanco

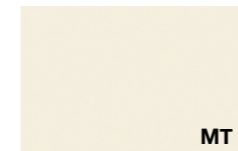

Talco
 Talco
 Talco
 Talco



Ocre
 Ochre
 Ocre
 Ocre



Safari
 Safari
 Safari
 Safari



Noisette
 Noisette
 Noisette
 Noisette

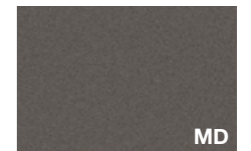

Ardesia
 Ardesia
 Ardesia
 Pizarra



Nero
 Black
 Noir
 Negro



Blu notte
 Night blue
 Bleu nuit
 Azul noche



Rovere chiaro
 Light oak
 Chêne clair
 Roble claro



Rovere americano
 American oak
 Chêne américain
 Roble americano



Rovere grigio
 Grey oak
 Chêne gris
 Roble gris



Rovere moro
 Dark oak
 Chêne foncé
 Roble oscuro



Noce Canaletto
 Canaletto Walnut
 Noyer Canaletto
 Nogal Canaletto



Noce scuro
 Dark walnut
 Noyer foncé
 Nogal oscuro

LGN

Legno

Wood | Bois | Madera

TOP



Rovere chiaro
 Light oak
 Chêne clair
 Roble claro



Rovere grigio fumo
 Smoke grey oak
 Chêne gris de fumée
 Roble gris humo



Rovere moro
 Dark oak
 Chêne foncé
 Roble oscuro



Noce Canaletto
 Canaletto Walnut
 Noyer Canaletto
 Nogal Canaletto



Ebano Silver
 Silver ebony
 Ebony Silver
 Ebano plata

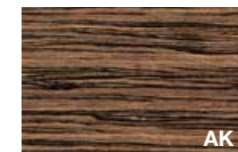

Ebano Makassar
 Makassar ebony
 Ebony Makassar
 Ebano Makassar



Noce termocotto
 Heat-treated walnut
 Noyer thermo traité
 Nogal termotratado

FNX
Fenix

Fenix | Fenix | Fenix



Bianco
White
Blanc
Blanco



Beige Arizona
Arizona beige
Beige Arizona
Beige Arizona



Blu Fes
Fes blue
Bleu Fes
Azul Fes



Grigio Bromo
Bromo grey
Gris Bromo
Gris Bromo



Verde Comodoro
Comodoro green
Vert Comodoro
Verde Comodoro

TOP



Nero
Black
Noir
Negro



Rosso Jaipur
Jaipur red
Rouge Jaipur
Rojo Jaipur

TES
Tessuto

Fabric | Tissu | Tejido



Beige
Beige
Beige
Beige



Grigio chiaro
Light grey
Gris clair
Gris claro



Ardesia
Ardesia
Ardesia
Pizarra



Blu avio
Avio blue
Bleu avio
Azul avio



Acquamarina
Aquamarine
Aigue-marine
Aguamarina

SCR

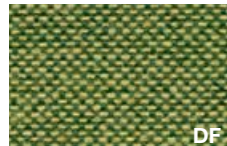

Verde primavera
Spring green
Vert printemps
Verde primavera

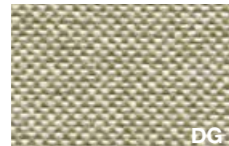

Salvia
Sage
Sauge
Salvia



Arancio
Orange
Orange
Naranja



Corallo
Coral
Corail
Coral

EPX
Epossidico

Epoxy | Époxy | Epoxi



Bianco
White
Blanc
Blanco



Talco
White
Talco
Talco



Grigio
Grey
Gris
Gris



Sabbia
Cream
Sable
Arena



Noisette
Noisette
Noisette
Noisette

STRU



Beige Arizona
Arizona beige
Beige Arizona
Beige Arizona



Blu notte
Night blue
Bleu nuit
Azul noche



Grigio Bromo
Bromo grey
Gris Bromo
Gris Bromo

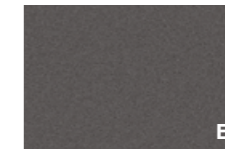

Ardesia
Ardesia
Ardesia
Pizarra



Verde scuro
Deep green
Vert foncé
Verde oscuro



Verde oliva
Olive green
Olive vert
Verde oliva



Oro
Gold
Or
Oro



Rame
Copper
Cuivre
Cobre

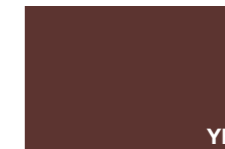

Rosso Jaipur
Jaipur red
Rouge Jaipur
Rojo Jaipur



Bronzo
Bronze
Bronze
Bronce



Nero
Black
Noir
Negro

Applicazioni finiture

Finish application | Application finitions | Aplicacion acabados

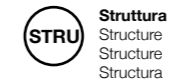

Le finiture contenute nella stampa sono puramente indicative e non sono di riferimento per le forniture del prodotto
Due to the printing process, finishes shown in this document are for illustration only. The finish on the final item may differ slightly from the printed illustration
Les finitions contenues dans l'impression sont purement indicatives et ne sont pas pertinentes pour les fournitures du produit
Los acabados contenidos en la impresión son puramente indicativos y no son de referencia para los suministros del producto

Ambiente e sicurezza | Environment and safety | Environnement et sécurité | Medio ambiente y seguridad

Alea utilizza per i suoi prodotti e i suoi imballi materiali facilmente separabili e riciclabili.
Nella produzione dei suoi manufatti, Alea si impegna ad utilizzare materiali legnosi FSC e pannelli a base di legno con certificazione CARB2. I pannelli CARB2 presentano un rilascio di formaldeide inferiore rispetto al pannello E1 comunemente utilizzato (classe E1 secondo il DM 10/10/2008).

Alea uses materials that are easy to separate and recycle for its products and packaging.
Alea is committed to using FSC wood-based materials and CARB2-certified wood-based panels.
CARB2 panels have a lower formaldehyde release than the commonly used E1 panel (class E1 according to DM 10/10/2008).

Alea utilise des matériaux facilement séparables et recyclables pour ses produits et ses emballages.
Dans la production de ses produits, Alea s'engage à utiliser des matériaux en bois FSC et des panneaux à base de bois avec la certification CARB2. Les panneaux CARB2 dégagent moins de formaldéhyde que le panneau E1 couramment utilisé (classe E1 selon DM 10/10/2008).

Para sus productos y embalajes, Alea utiliza materiales fácilmente separables y reciclables.
En la fabricación de sus productos, Alea se compromete a utilizar materiales de madera FSC y paneles de madera con certificación CARB2. Los paneles CARB2 tienen una menor liberación de formaldehído que el panel E1 comúnmente utilizado (clase E1 según DM 10/10/2008).

Concept & design

Alea marketing + communication

Art director

Mirto Antonel

Product design

Mirto Antonel

Si ringrazia M.artedesign

martedesign.it

AC/CACD/AF

Le immagini dei prodotti visibili all'interno di questo catalogo sono inserite a scopo puramente indicativo
The images of the products visible in this catalogue are included for information purposes only
Les images des produits visibles dans ce catalogue sont incluses à titre informatif uniquement
Las imágenes de los productos visibles en este catálogo se incluyen sólo con fines informativos

alea
aleaoffice.com



GLOBAL HEADQUARTERS AND SHOWROOM : Via Col de Rust, 19 - 33070 Sarone (PN) - Italia : Tel ++39 0434 777 333
email: info@aleaoffice.com **PARIS SHOWROOM** : 176 Avenue Charles de Gaulle 92200, Neuilly-sur-Seine - France **NORTH AMERICAN
HEADQUARTERS** : Midtown 2, 3449 NE 1st Avenue L-32, Miami, FL 33137 - USA : Tel ++1 305 470 1200 - email: info@alea-usa.com
ALEA UK OFFICE AND SHOWROOM : 50-54 Clerkenwell Road, London EC1M 5PS - email: info@aleaoffice.com