

alea

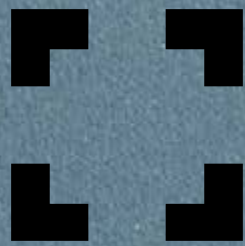

Italo_forty

workstations

Solo l'essenziale

Il pratico sistema di fissaggio a molla, rende Italo_forty una struttura solida, affidabile e performante nel tempo.

The practical spring fastening system makes Italo_forty a solid, reliable and long-lasting structure.

Le système pratique de fixation par ressort fait d'Italo_forty une structure solide, fiable et durable.

El práctico sistema de fijación por muelle hace de Italo_forty una estructura sólida, fiable y duradera.

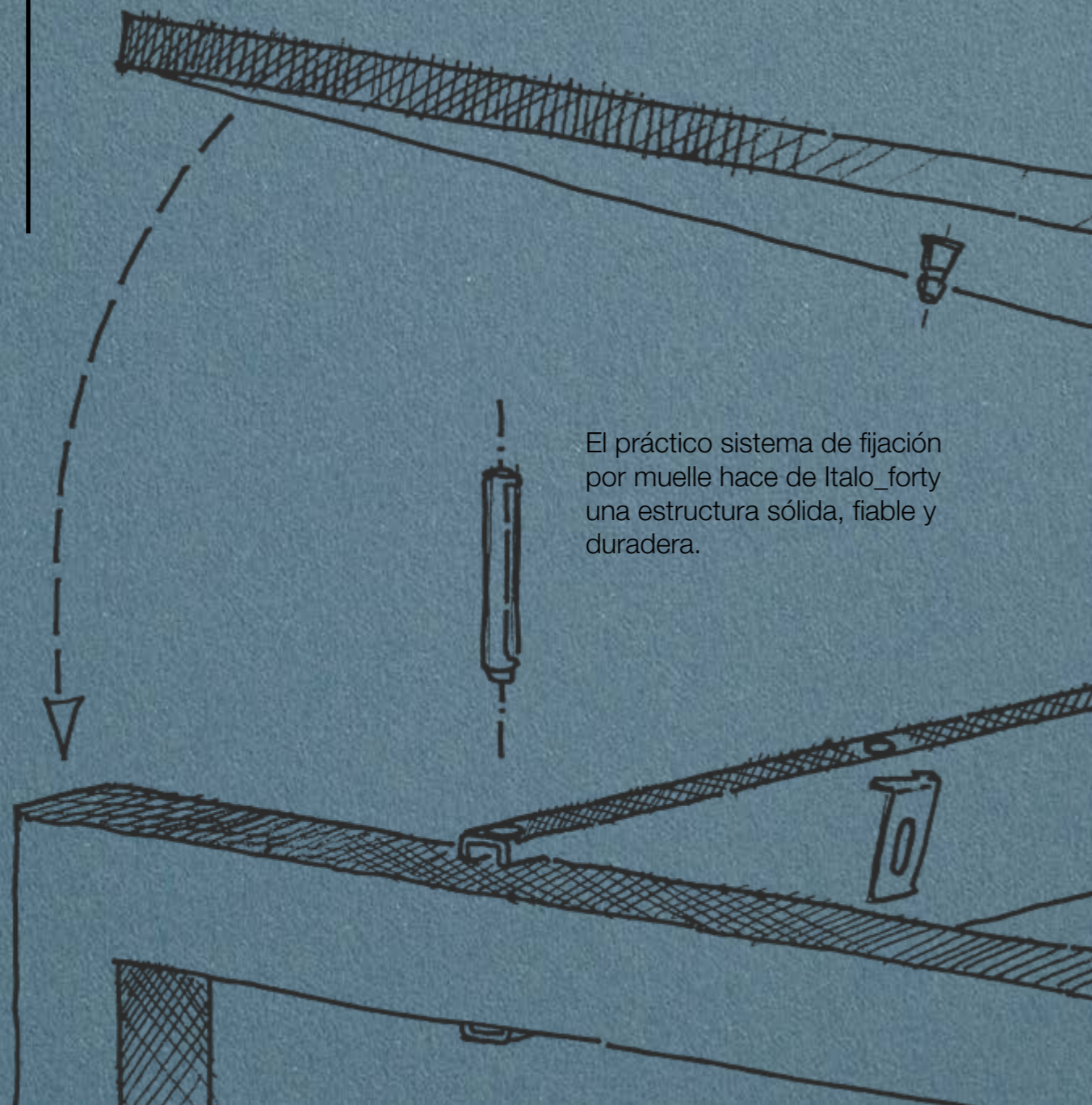

Sistema intelligente

Italo_forty è un sistema dalle sorprendenti prerogative tecniche ma dai costi contenuti. Si compone di una struttura metallica trave/cavalletto di supporto ai piani di spessore 18 mm.

Smart system Italo_forty system combines great technical features with cost efficient components. A metal structure with horizontal beams and straight legs, supports tops 18 mm (11/16") thick.

Système intelligent Italo_forty est un système aux surprenantes caractéristiques techniques mais au prix contenu. Le système se compose d'une structure métallique poutre/pied arche à support de plateaux de 18 mm d'épaisseur.

Sistema inteligente Italo_forty es un sistema de sorprendentes características técnicas a un precio razonable. El sistema consta de una estructura metálica de patas/vigas que soporta superficies de 18 mm de espesor.





Fissaggio

Il fissaggio dei piani alla struttura avviene grazie a perni conici che si inseriscono su molle metalliche applicate alle travi. Il piano si installa solo a pressione, senza l'utilizzo di viti. Le travi orizzontali forniscono anche il supporto agli accessori.



Fixation la fixation des plateaux sur la structure se fait grâce à des goujons coniques qui sont insérés dans des ressorts métalliques intégrés aux poutres. Le plan de travail est installé simplement par pression, aucune vis. Les poutres horizontales servent également de support aux accessoires.

Fijación los sobres de mesa, se conectan a la base por medio de pernos que se introducen en resortes metálicos aplicados en las vigas. La sola presión del peso es suficiente para instalar el top, sin necesidad de tornillos. Las vigas horizontales también sirven para colocar los accesorios.

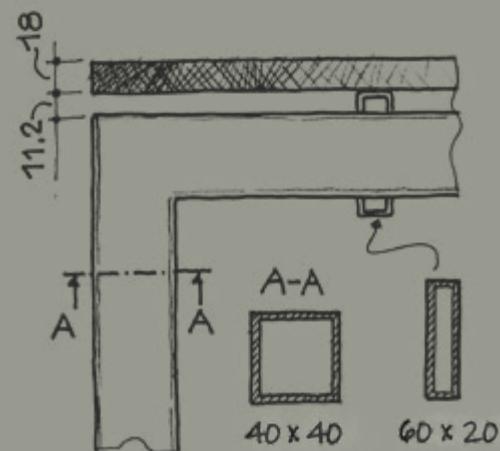

Fixing the worksurface is secured to the structure through conical pins which are inserted onto metal springs applied to the beams. The table top is installed only by pressure, without the use of screws. The horizontal beams also provide support to several accessories.





Al tavolo Italo_forty possiamo abbinare Q18, sistema modulare di librerie realizzato con un profilo in alluminio a sezione quadrata da 18 mm e integrabile con moduli contenitori e piani espositori.

Italo_forty table can be paired with Q18, a modular bookcase system made with an 18 mm (11/16") square section aluminium profile that can be integrated with storage modules and display shelves.

La table Italo_forty peut être assortie à Q18, système modulaire de rayonnage réalisé avec un profil en aluminium à section carrée de 18 mm pouvant être complété avec rangements et présentoirs.

A la mesa Italo_forty podemos combinar Q18, sistema de estantería modular hecho con perfil de aluminio de sección cuadrada de 18 mm que se puede integrar con módulos contenedores y estantes expositores.





Options Italo_forty tops can be in melamine, with a solid colour or wood-effect finish, or in back-lacquered glass, also in the anti-fingerprint version.

Options Les plateaux Italo_forty peuvent être en mélamine, avec finition unie ou effet bois, ou en verre laqué, également dans la version antitaches.

Opciones Los sobres Italo_forty pueden ser de melamina, con un acabado de color sólido o de efecto madera, o de cristal retro-lacado, también en la versión anti-huella.



Opzioni

I piani Italo_forty possono essere in melaminico, con finitura in tinta unita o effetto legno, oppure in vetro retrolaccato anche nella versione antimpronta.



Contenitori

I sistemi di contenitori ad ante battenti Remo e ad ante scorrevoli Romolo si abbinano con i tavoli Italo_forty condividendo le molte opzioni di colore.



Storage Italo_forty can be paired with Remo hinged doors storage system and Romolo sliding doors cabinets. They all share the same range of finishes.

Armoires de rangement
Les armoires à portes battantes Remo et à portes coulissantes Romolo s'assortent bien avec les tables Italo_forty grâce aux nombreuses options couleur communes.

Contenedores Los sistemas de almacenamiento de puertas batientes Remo y de puertas corredizas Romolo se combinan con las mesas. Italo_forty compartiendo las múltiples opciones de color.







Accessori

Il piano può essere dotato di asola passacavi o di spazzola morbida per consentire l'uscita dei cavi sul piano lavoro. Il bench Italo_forty può essere attrezzato con corpetti contenitori, a giorno, condivisi e screen agganciati in tessuto tackable.

Accessories The top can be provided with grommets or soft brush flip top that allow cables to reach easily the top of the worksurface. Screens may be tackable and cubbies can be added and shared in a bench configuration.

Accessoires Le plateau peut être équipé avec une brosse douce qui permet la sortie des câbles sur le plan de travail. Le poste double Italo_forty peut recevoir soit des petits rangements ouverts partagés soit des écrans de séparation "tackable" en tissu.

Accesorios La superficie de trabajo puede llevar una ranura pasacables o un cepillo suave para permitir la salida de los cables en la encimera. El bench Italo_forty puede ser equipado con contenedores aéreos, abiertos, compartidos y pantallas enganchadas en tejido pinchable.







Cablaggio

Il sistema di traslazione dei piani lavoro nelle postazioni contrapposte consente un facile accesso al vano centrale dove vengono raccolti i cavi. Questo spazio condiviso può essere attrezzato con una vasca in metallo o una rete metallica effetto cromato.

Wiring In the face to face stations, Italo_forty sliding system allows easy access to the center through where the cables run. The channel can be in metal or in a grid chrome version.

Câblage L'option des plateaux à coulisse permet, en hâlant la surface de travail, de libérer l'accès à l'aire de connexion où se trouve le câblage. Celui-ci est véhiculé par des canaux réalisés soit en maillage d'acier chromé soit en tôle peinte pliée en U.

Cableado Las superficies con sistema deslizable en los escritorios compartidos permite un acceso fácil al canal central que distribuye los cables y conexiones. Este canal compartido puede ser una canasta en rejilla de metal cromado o una bandeja metálica en U.



Sala lettura

Quando abbinato al sistema di librerie modulari Q18, Italo_forty si rivela adatto per l'arredamento di ambienti come le sale lettura. Le forme geometriche creano spazi di lavoro accoglienti e attraenti



Libraries When paired with the Q18 modular shelving system, Italo_forty is suitable for furnishing environments such as libraries. Geometric shapes create welcoming and comfortable areas.

Salles de lecture Associé au système de rayonnage modulaire Q18, Italo_forty devient la solution idéale pour l'ameublement d'espaces tels que salles de lecture. Les formes géométriques créent d'espaces de travail confortables et séduisants.

Ambientes de lectura Cuando se combina con el sistema de estantería modular Q18, Italo_forty demuestra ser adecuado para el amueblamiento de interiores como salas de lectura. Las formas geométricas crean espacios de trabajo acogedores y atractivos.





Riunioni

Italo_forty consente, grazie alla propria struttura, di realizzare tavoli riunione con campata sino a 300 cm senza l'ausilio di supporti intermedi. Ai tavoli si possono abbinare eleganti librerie modulari in varie finiture oppure mobili contenitori.

Meetings Italo_forty beam system allows the building of conference tables 300 cm (10 feet) long without an intermediate support. These tables can be paired with modular bookcases and elegant cabinets.



Réunions Italo_forty grâce à son concept structurel permet de concevoir des tables de réunion jusqu'à 300 cm sans support intermédiaire. Ces tables proposent en complément d'élégants bibliothèques à jour (déclinées dans toutes les finitions Alea) ou alors des armoires.

Reuniones Gracias al soporte fuerte de las estructuras, Italo_forty permite confeccionar mesas de hasta 300 cm sin soportes intermedios. Las mesas se pueden complementar con elegantes libreros modulares en varios acabados o con archivos.

①



1. Tavoli lunghezza extra, 300 mm | 2. Accessori agganciati alla struttura (screen, modesty panel, porta CPU) | 3. Rapido fissaggio del top | 4. Componenti della struttura | 5. Gamba regolabile in altezza | 6. Piano traslabile | 7. Design lineare

②



1. Extra long tables, 300 mm (10 feet) | 2. Accessories hung to the structure (screen, modesty panel, CPU holder) | 3. Quick top linking | 4. Structure components | 5. Height adjustable leg | 6. Sliding desk top | 7. Clean design

③



1. Tables extra-longues, 300 mm | 2. Accessoires fixés à la structure (ecran, voile de fond, Support U.C.) | 3. Fixation rapide du top | 4. Composants de la structure | 5. Pied réglable en hauteur | 6. Plateau coulissant | 7. Design linéaire

1. Mesas de longitud extra, 300 mm | 2. Accesorios enganchados en la estructura (panel, faldón, porta CPU) | 3. Anclaje rápido del sobre mesa | 4. Componentes de la estructura | 5. Pata regulable en altura | 6. Plateau coulissant | 7. Diseño lineal

④



⑥



⑤



⑦

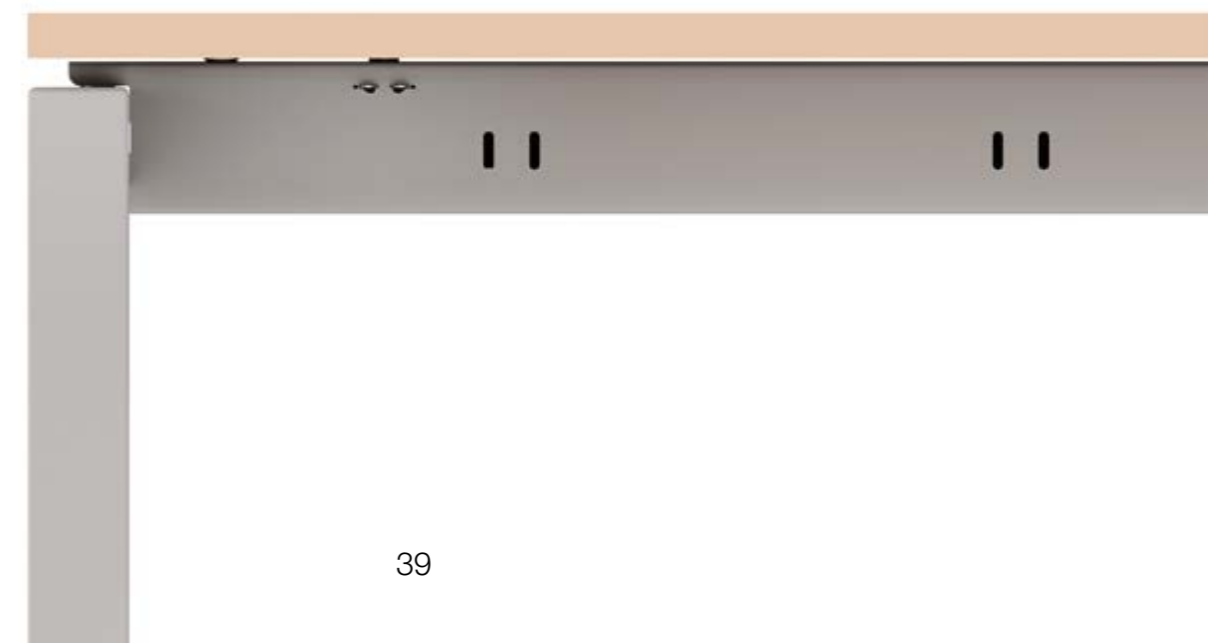

8

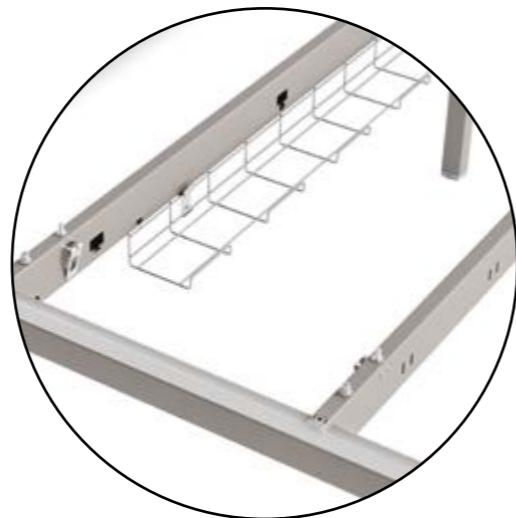

8. Cestello portacavi in filo d'acciaio | 9. Canala portacavi in metallo | 10. Gestione dei cavi nella soluzione bench | 11. Canale metalliche magnetiche per il transito verticale dei cavi | 12. Coppia di carter per la salita cavi

8. Basket for cable management | 9. Metal tray for cable management | 10. Cable management for bench solutions | 11. Magnetic vertical cable duct | 12. Double vertical cable duct

8. Panier passecables en fil d'acier | 9. Goulotte passecables en tôle d'acier | 10. Gestion des câbles dans la solution bench | 11. Goulottes verticales magnétiques pour passage câbles | 12. Goulotte double verticale passecables

8. Viga portacables en rejilla de acero | 9. Viga portacables | 10. Gestión de cables en la solución de cables en la solución bench | 11. Canalización magnética para salida cables | 12. Canalización central para salida cables

10



11

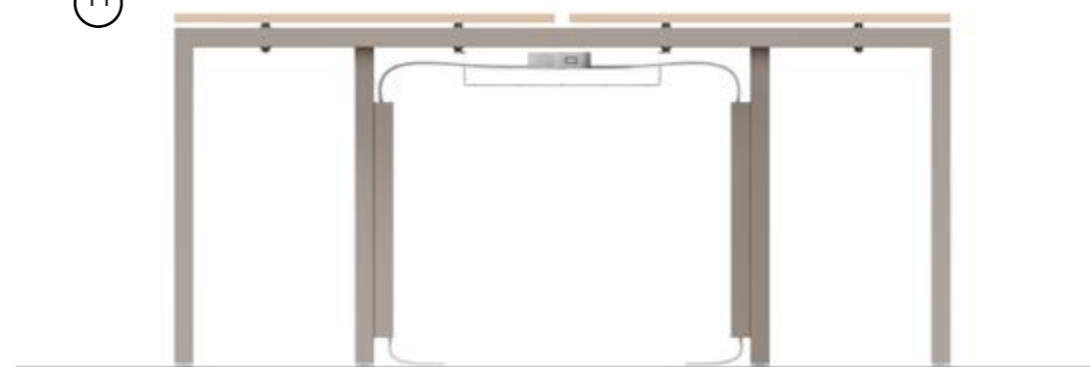

12



9



Melaminico/vetro
Melamine/glass
Mélaminé/verre
Melaminico/vidrio

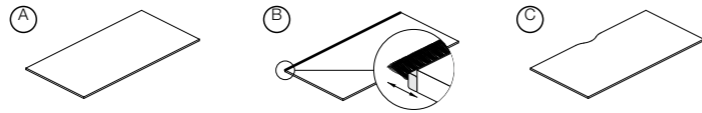

Piani fissi o traslabili A. semplici, B. con spazzolino, C. con scanso passacavi

Fixed or sliding desk tops A. simple, B. with brush, C. with frontal shaping for cable transit
Plateaux fixes ou coulissants A. simples, B. avec brosse passe-câbles, C. avec façonnage frontal pour le passage des câbles
Sobres fijas o deslizantes A. simples, B. con escobillas, C. con pasacables frontal

Gambe | Legs | Pieds | Patas

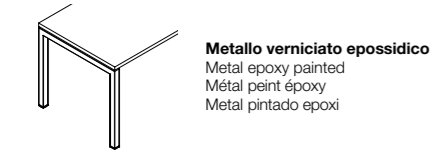

Metallo verniciato epossidico
Metal epoxy painted
Métal peint époxy
Metal pintado epoxi

Gli screen sono disponibili nelle finiture: melaminico, gofrato, metacrilato, tessuto

Screens are available in the following finishes: melamine, embossed, acrylic, fabric
Les écrans sont disponibles dans les finitions: mélaminé, gaufré, méthacrylate, tissu
Los paneles están disponibles en los siguientes acabados: melaminico, lacado, metacrilato, tejido

Scrivanie | desks | bureaux | mesas

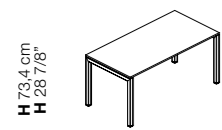

L 100/120/140/160/180/200 - P 80/90 cm
W 39 3/8"-47 1/4"-55 1/8"-63"-70 7/8"-78 3/4" - D 31 1/2"-35 3/8"

Dattilo | returns | retours | alas

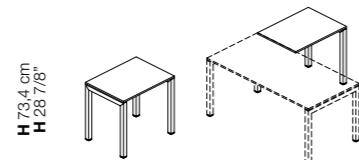

L 80/100/120 - P 60 cm
W 31 1/2"-39 3/8"-47 1/4" - D 23 5/8"

Tavoli riunione | meeting tables | tables de réunion | mesas de juntas

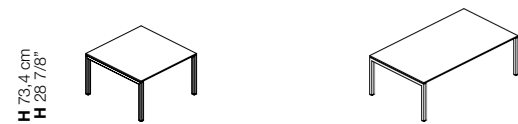

L 120/160 - P 123/163 cm
W 47 1/4"-63" - D 48 3/8"-64 1/8"

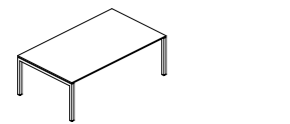

L 210/240/300 - P 123 cm
W 82 5/8"-94 1/2"-118 1/8" - D 48 3/8"

Esempi composizioni | composition example | exemples de compositions | ejemplos de composiciones

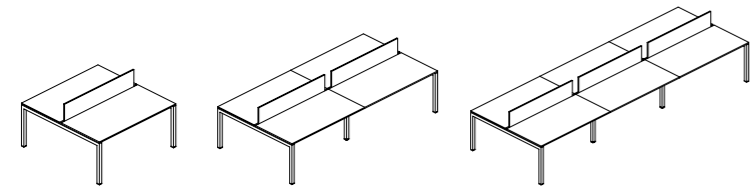

Finiture | Finishes | Finitions | Acabados

MEL

Melaminico

Melamine | Mélaminé | Melaminico



Bianco rigato Rippled effect white Blanc avec rayures en sérigraphie Blanco rayado	Grigio rigato Rippled effect grey Gris avec rayures en sérigraphie Gris rayado	Nichel Nickel Nickel Níquel	Cacao Cocoa Cacao Cacao	Bianco White Blanc Blanco
Talco Talc Talc Talco	Ocre Ochre Ocre Ocre	Safari Safari Safari Safari	Noisette Noisette Noisette Noisette	Ardesia Ardesia Ardesia Pizarra
Nero Black Noir Negro	Blu notte Night blue Bleu nuit Azul noche	Rovere chiaro Light oak Chêne clair Roble claro	Rovere americano American oak Chêne américain Roble americano	Rovere grigio Grey oak Chêne gris Roble gris
Rovere moro Dark oak Chêne foncé Roble oscuro	Noce Canaletto Canaletto Walnut Noyer Canaletto Nogal Canaletto	Noce scuro Dark walnut Noyer foncé Nogal oscuro		

GOF

Goffrato

Embossed | Gaufré | Lacado

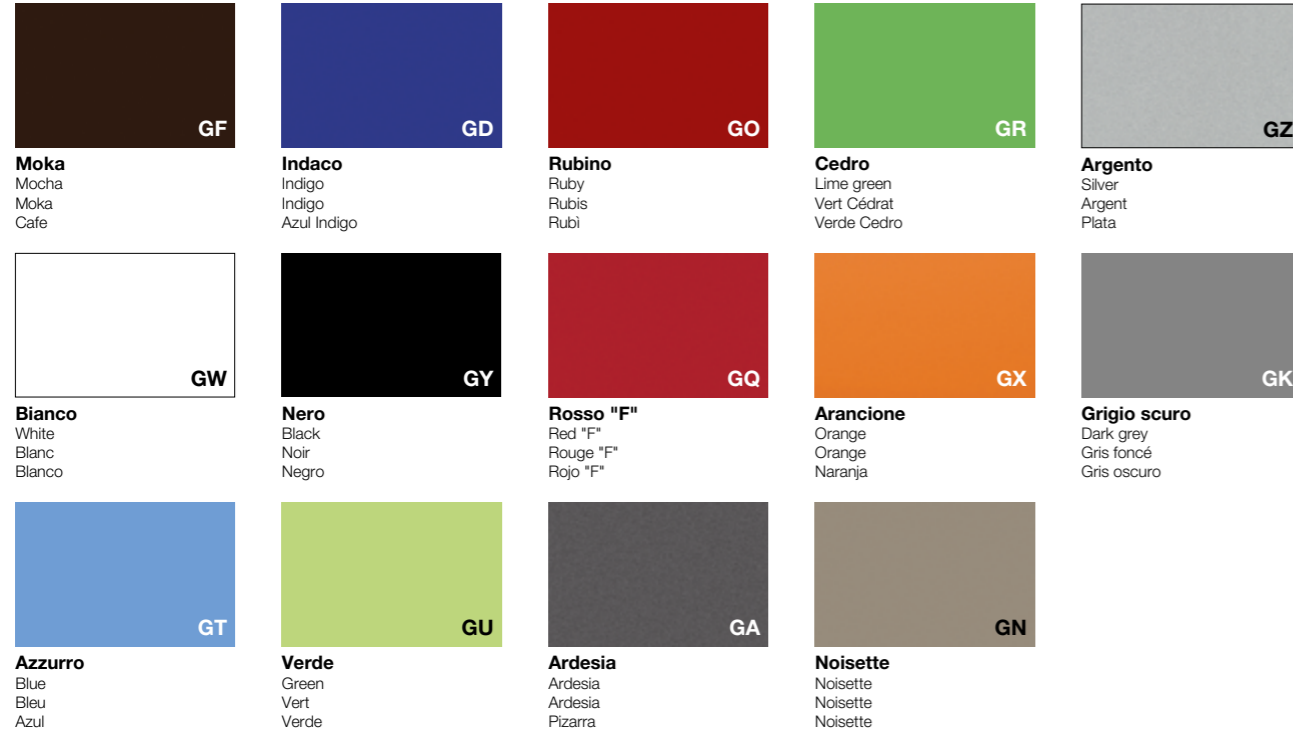

SCR

MTC

Metacrilato

Acrylic | Méthacrylate | Metacrilato



SCR

Le finiture contenute nella stampa sono puramente indicative e non sono di riferimento per le forniture del prodotto
Due to the printing process, finishes shown in this document are for illustration only. The finish on the final item may differ slightly from the printed illustration
Les finitions contenues dans l'impression sont purement indicatives et ne sont pas pertinentes pour les fournitures du produit
Los acabados contenidos en la impresión son puramente indicativos y no son de referencia para los suministros del producto

TES

Tessuto

Fabric | Tissu | Tejido

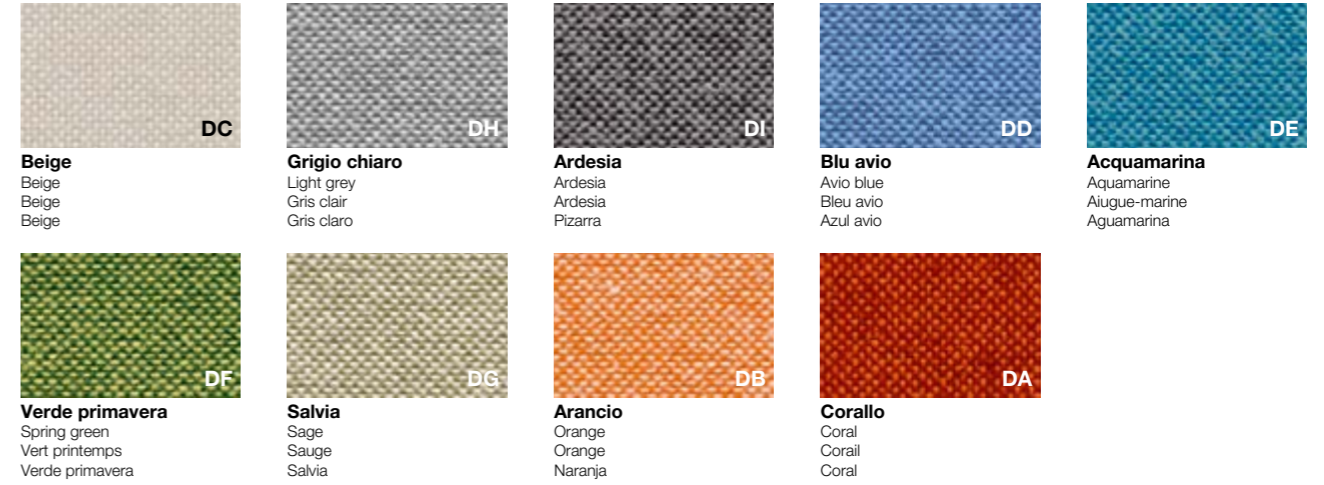

SCR

EPX

Epossidico

Epoxy | Époxy | Epoxi



STRU

Applicazioni finiture

Finish application | Application finitions | Aplicacion acabados



Ambiente e sicurezza | Environment and safety | Environnement et sécurité | Medio ambiente y seguridad

Ecologia Alea utilizza per i suoi prodotti e i suoi imballi materiali facilmente separabili e riciclabili.

Attestazione di prodotto I prodotti Alea sono stati sottoposti a prove prestazionali presso laboratori di prova accreditati. Copia dei rapporti di prova o delle attestazioni di conformità sono disponibili su richiesta. I prodotti Alea soddisfano i requisiti LEED per il credito IEQ4.5 per i materiali a bassa emissione ed i requisiti ANSI/BIFMA X7.1-2011. Alea dichiara di utilizzare pannelli a base di legno aventi un rilascio di formaldeide conforme alla classe E1 secondo il DM 10/10/2008. Alea si impegna inoltre ad utilizzare materiali legnosi FSC e pannelli a base di legno con certificazione CARB2.

Environment Alea products and packaging are made of recyclable materials.

Product certification Alea products have been subjected to performance tests at accredited testing laboratories. Copies of test reports or certificates of conformity are available on request. Alea products meet the LEED requirements for IEQ4.5 credit for low emission materials and the ANSI/BIFMA X7.1-2011 requirements. Alea declares to use wood-based panels with a formaldehyde release according to class E1 according to DM 10/10/2008. Alea also undertakes to use FSC wood-based materials and CARB2-certified wood-based panels.

Environnement Alea utilise des matériaux facilement séparables et recyclables pour ses produits et ses emballages.

Certification de produits Les produits Alea ont été soumis à des tests de performance dans des laboratoires accrédités. Des copies des rapports d'essais ou des certificats de conformité sont disponibles sur demande. Les produits Alea répondent aux exigences LEED pour le crédit IEQ4.5 pour les matériaux à faibles émissions et aux exigences ANSI/BIFMA X7.1-2011. Alea déclare utiliser des panneaux à base de bois avec un dégagement de formaldéhyde selon la classe E1 selon DM 10/10/2008. Alea s'engage également à utiliser des matériaux à base de bois FSC et des panneaux à base de bois certifiés CARB2.

Ecología Alea utiliza productos y embalajes en materiales fácilmente separables y reciclables.

Certificación de producto Los productos Alea han sido sometidos a pruebas de rendimiento en laboratorios de pruebas acreditados. Copias de los informes de las pruebas o certificados de conformidad están disponibles bajo petición. Los productos Alea cumplen con los requisitos LEED para el crédito IEQ4.5 para materiales de baja emisión y los requisitos ANSI/BIFMA X7.1-2011. Alea declara utilizar paneles de madera con una emisión de formaldehído según la clase E1 según DM 10/10/2008. Alea también se compromete a utilizar materiales a base de madera FSC y paneles a base de madera certificados por CARB2.

Concept & graphic design

Alea marketing + communication

Design

Filippon & Mirto Antonel

Art direction

Mirto Antonel

AD/CACC/AG

Le immagini dei prodotti visibili all'interno di questo catalogo sono inserite a scopo puramente indicativo
The images of the products visible in this catalogue are included for information purposes only
Les images des produits visibles dans ce catalogue sont incluses à titre informatif uniquement
Las imágenes de los productos visibles en este catálogo se incluyen sólo con fines informativos

alea
aleaoffice.com



GLOBAL HEADQUARTERS AND SHOWROOM : Via Col de Rust, 19 - 33070 Sarone (PN) - Italia : Tel ++39 0434 777 333
email: info@aleaoffice.com **PARIS SHOWROOM** : 176 Avenue Charles de Gaulle 92200, Neuilly-sur-Seine - France **NORTH AMERICAN**
HEADQUARTERS : Midtown 2, 3449 NE 1st Avenue L-32, Miami, FL 33137 - USA : Tel ++1 305 470 1200 - email: info@alea-usa.com
ALEA UK OFFICE AND SHOWROOM : 50-54 Clerkenwell Road, London EC1M 5PS - email: info@aleaoffice.com